



Surface-mount Fuses Telecom Fuses

The telecom FT600 fuse helps telecommunications equipment manufacturers comply with North American overcurrent protection requirements, including Telcordia GR-1089, TIA-968-A (formerly FCC Part 68), and UL60950 3rd edition.

Tyco Electronics' telecom fuses offer low temperature-rise performance under sneak current fault events to help prevent damage to circuit traces or multilayer boards, and their low profile and small footprint make them suitable for high-density and space-constrained applications.



Benefits

- High density placement in multi-port system designs
- Improved temperature rise performance over other similar surface-mount fuse devices under sneak current testing
- The FT600, in conjunction with a thyristor surge suppression device, assists designers to meet regulatory standards without additional series components

Features

- Lead free materials and RoHS compliant
- Halogen free
(refers to: Br≤900ppm, Cl≤900ppm, Br+Cl≤1500ppm)
- Low profile and small footprint
- The lightning robust surface-mount fuse offers overcurrent protection in case of power fault events
- Enables the design of equipment complying with applicable telecom specifications including UL60950, TIA-968-A, and Telcordia GR-1089
- Low resistance

Applications

- ADSL, ADSL2, ADSL2plus, SHDSL, VDSL linecards and modems
- T1/E1 systems
- Twisted-pair telecom ports requiring Telcordia GR-1089, UL60950 and FCC Part TIA-968-A compliance

Protection Application Guide for Telecommunications and Networking Devices

To use this guide, follow the steps below:

1. Select your equipment type from the guide below.
2. Use the Key Device Selection Criteria (time-to-open, surface temperature) to determine best suitability for your application.
3. Use Agency Specification / Selection Guide to select a specific part number for each application based on the agency requirements.

Key Device Selection Criteria

Application	Specification	Faster Time-To-Open	Cooler Surface Temperature
Customer premises equipment, IT equipment Analog modems, V.90 modems, ISDN modems, xDSL modems, ADSL splitters, phone sets, fax machines, answering machines, caller ID, internet appliances, PBX systems, POS terminals, wall plugs	UL 60950 TIA-968-A	FT600-0500 FT600-1250	FT600-2000
Access network equipment Remote terminals, line repeaters, multiplexers, cross-connects, WAN equipment	Telcordia GR-1089 TIA-968-A	FT600-1250	FT600-2000
Central office switching equipment Analog/POTS linecards, ISDN linecards, xDSL modems, ADSL/VDSL splitters, T1/E1 linecards, multiplexers, CSU/DSU, servers	Telcordia GR-1089 TIA-968-A	FT600-1250	FT600-2000

Note: This list is not exhaustive. Tyco Electronics welcomes our customers' input for additional application ideas for overcurrent protection of telecom applications.

Agency Specification/Selection Guide for FT600 Devices

Use the guide below to select FT600 devices appropriate for use in your application. The following pages contain specifications for part numbers recommended below. FT600 devices enable telecommunication equipment to meet the applicable protection requirements of these industry specifications. Refer to individual agency specifications for test procedures and circuit schematics. Users should independently evaluate the suitability of, and test each product for their application.

Family	Product	Lightning	Power Cross
FT600	FT600-0500	TIA-968-A – Types A & B	UL60950, 3rd Ed. – 600V _{AC} , 40A
	FT600-1250	Telcordia GR-1089 – Level 1 and 2	Telcordia GR-1089 – 600 V _{AC} , 40A
	FT600-2000	TIA-968-A	UL60950

Notes: FT600-1250 and FT600-2000 assist equipment in complying with Telcordia GR-1089 specifications. In-circuit testing is strongly recommended. The FT600-0500, FT600-1250 and FT600-2000 help meet the UL60950 Power Cross and FCC TIA-968-A 68 lightning surge requirements. Note that Type A tests allow for an overcurrent protection component to fuse open during the surge.

Table FT1 Interrupt Voltage and Current Ratings for FT600 Devices

Part Number	Ampere Rating (A)	Voltage Rating (V)	Typical Resistance (Ω)	Typical I ² t (A ² s)*
FT600-0500	0.50	250	0.50	1
FT600-1250	1.25	250	0.10	16
FT600-2000	2.00	250	0.05	18

Note: The FT600-xxxx devices carry 100% of rated current for 4 hours minimum and 250% of rated current for 1 second minimum, 120 seconds maximum. Resistance measured at 10% of rated current.

*I²t is calculated at 10 ms or less.

Figure FT1 Thermal Derating Curve (Normalized) for FT600 Devices

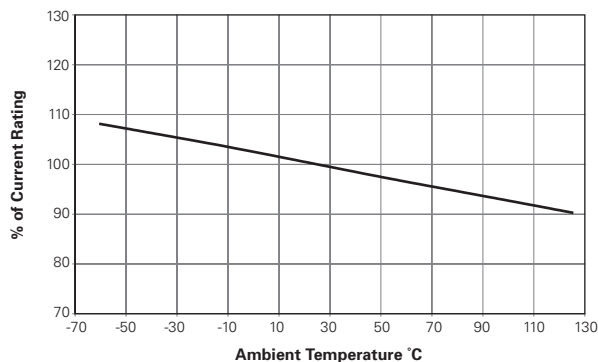

Table FT2 Dimensions for FT600 Devices in Millimeters (Inches)

Part Number	A		B		C		Figure
	Min.	Max.	Min.	Max.	Min.	Max.	
FT600-0500	—	10.2 (0.402)	—	3.1 (0.122)	—	3.1 (0.122)	FT2
FT600-1250	—	10.2 (0.402)	—	3.1 (0.122)	—	3.1 (0.122)	FT2
FT600-2000	—	10.2 (0.402)	—	3.1 (0.122)	—	3.1 (0.122)	FT2

Figure FT2 Dimension Figures for FT600 Devices

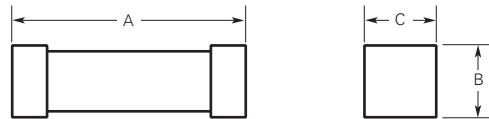

Figure FT3 Typical Time-to-open Characteristics (at 20°C) for FT600 Devices

FT600

- A = FT600-0500
- B = FT600-1250
- C = FT600-2000

Figure FT3

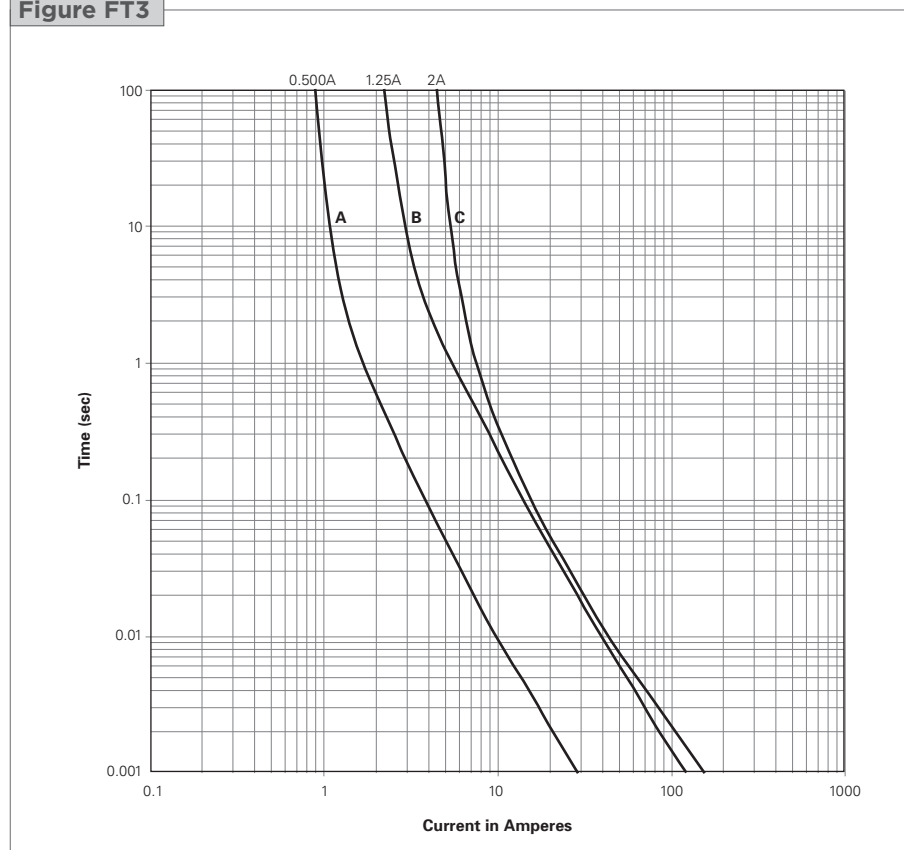

Table FT3 Physical Characteristics and Environmental Specifications for FT600 Devices

Physical Characteristics

Terminal material	Silver-plated brass*
Body material	Ceramic
Termination solderability	Per IEC-60127-4

*FT600 devices use high Pb content solder for internal construction. They are RoHS compliant.

Environmental Specifications

Test	Conditions
Solder heat withstand	Per MIL-STD-202, Method 210, Test Condition J
Solvent resistance	Per MIL-STD-202F, Method 215J
Storage temperature	≤30°C/ 85% RH
Storage humidity	Per MIL-STD-202F, Method 106F

Table FT4 Packaging and Marking Information for FT600 Devices

Part Number	Bag Quantity	Tape & Reel Quantity	Standard Package Quantity	Part Marking	Agency Recognition
FT600-0500-2	—	2,500	10,000	500	UL, CSA
FT600-1250-2	—	2,500	10,000	1250	UL, CSA
FT600-2000-2	—	2,500	10,000	2000	UL, CSA

Note: The -2 designates tape and reel, the package style for this product.

Table FT5 Recommended Pad Layouts for FT600 Devices in Millimeters (Inches) Nominal

Device	A	B	C	D	Figure for Dimensions
FT600-0500	12.6 (0.496)	4.0 (0.157)	3.7 (0.145)	5.2 (0.204)	FT4
FT600-1250	12.6 (0.496)	4.0 (0.157)	3.7 (0.145)	5.2 (0.204)	FT4
FT600-2000	12.6 (0.496)	4.0 (0.157)	3.7 (0.145)	5.2 (0.204)	FT4

Figure FT4

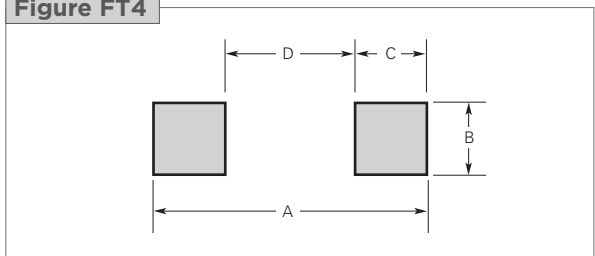

Solder Reflow and Rework Recommendations for FT600 Devices

Solder Reflow

- Recommended reflow methods: IR, vapor phase oven, hot air oven
- Devices can be cleaned using standard industry methods and solvents

Rework

- If a device is removed from the board, it should be discarded and replaced by a new device

Figure FT5

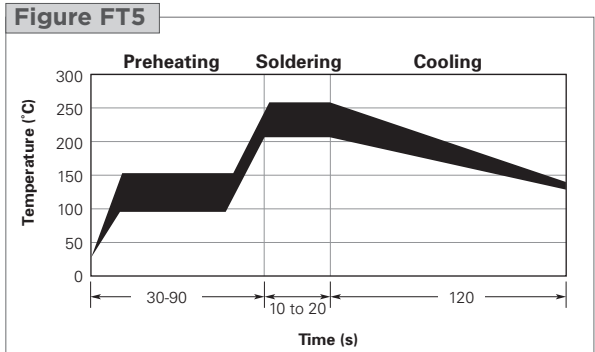
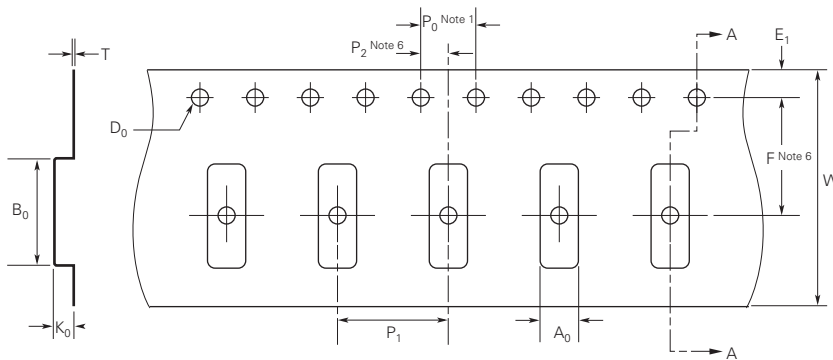

Table FT6 Tape and Reel Specifications for FT600 Devices

Dimension Description	EIA Mark	Dimension (mm)	Tolerance
Carrier tape width	W	24	±0.3
Sprocket hole pitch	P ₀	4	±0.1
	P ₁	8	±0.1
	P ₂	2	±0.1
	A ₀	3.68	±0.1
	B ₀	10.44	±0.1
Sprocket hole diameter	D ₀	1.5	+0.1 / -0.0
	F	11.5	±0.1
	E ₁	1.75	±0.1
Tape thickness	T max.	0.3	±0.05
	K ₀	3.25	+1.0 / -0.05
Reel Dimensions			
Reel diameter	A max.	331.5	
Core diameter	N min.	98.5	
Space between flanges less devices	W ₀	25	±0.5
Reel width	W ₁ max.	31	

Figure FT6 EIA Referenced Taped Component Dimensions for FT600 Devices



Notes:

1. 10 sprocket hole pitch cumulative tolerance ±0.2
2. Allowable camber to be 1mm/250mm
3. Material: Black conductive
4. A₀ and B₀ measured on a plane 0.3mm above the bottom of the pocket
5. K₀ measured from the plane on the inside bottom of the pocket to the top surface of the carrier
6. Pocket position relative to sprocket hole measured as true position of pocket, not pocket hole
7. Quantity per reel to be 174m

Figure FT7 EIA Referenced Reel Dimensions for FT600 Devices

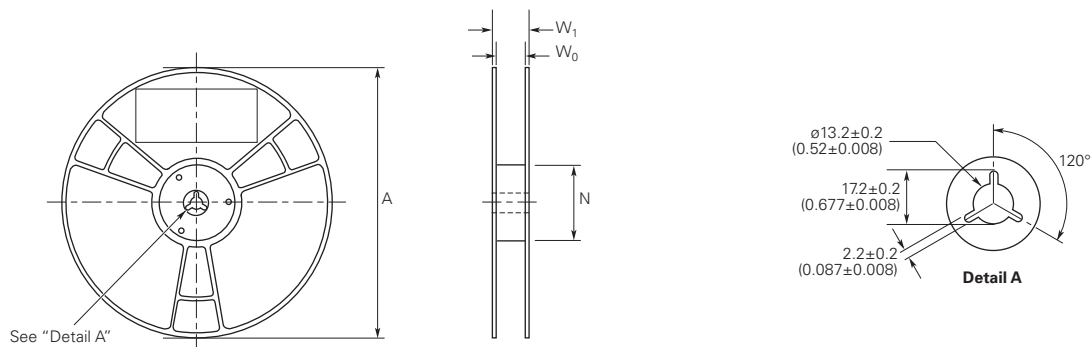

Part Numbering System for FT600 Devices

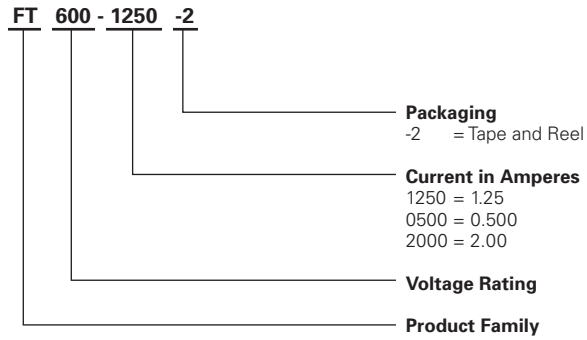

Warning :

All information, including illustrations, is believed to be accurate and reliable. Users, however, should independently evaluate the suitability of and test each product selected for their application. Tyco Electronics Corporation makes no warranties as to the accuracy or completeness of the information, and disclaims any liability regarding its use. Tyco Electronics' only obligations are those in the Tyco Electronics' Standard Terms and Conditions of Sale for this product, and in no case will Tyco Electronics be liable for any incidental, indirect, or consequential damages arising from the sale, resale, use, or misuse of the product. Specifications are subject to change without notice. In addition, Tyco Electronics reserves the right to make changes to materials or processing that do not affect compliance with any applicable specification without notification to Buyer.